

DRAWING NO.
030A0138

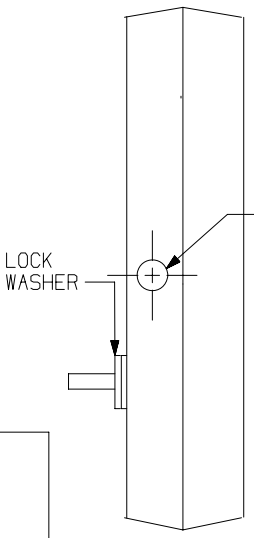

TERMINATE WIRES
WITH CRIMP PIN
MOLEX P/N 16-02-0102
AMP P/N 104480-2 OR
AMP - 1-104480-7

SHRINK WRAP
LENGTH 1 IN. MIN.

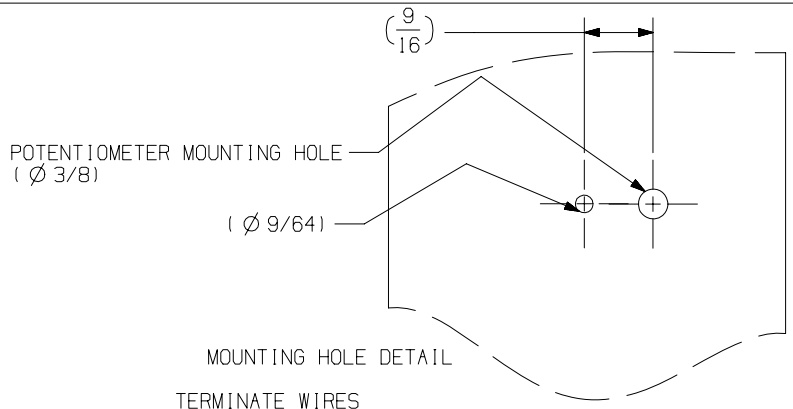
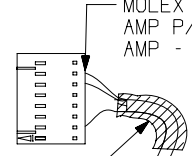

I.O. INTERCONNECT
MODULAR CABLE
6 CONDUCTOR, FLAT
4 FT LENGTH
UL STYLE 20251
24-26AWG

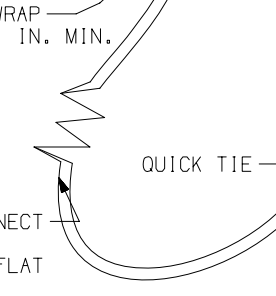

TIE CABLE INTERNAL
TO ENCLOSURE FOR STRAIN
RELIEF

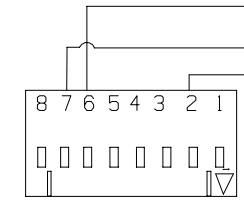
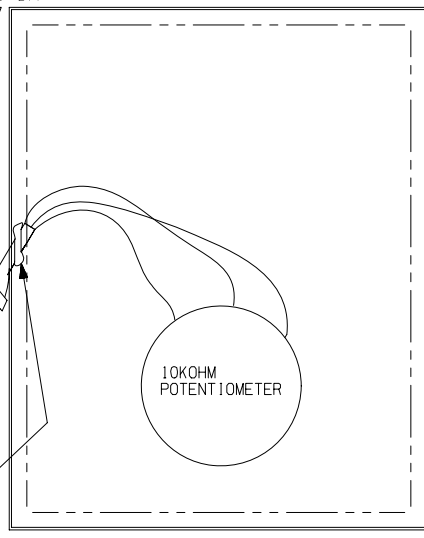

CONNECTOR
MOLEX P/N 50-57-9408
AMP P/N 104257-7

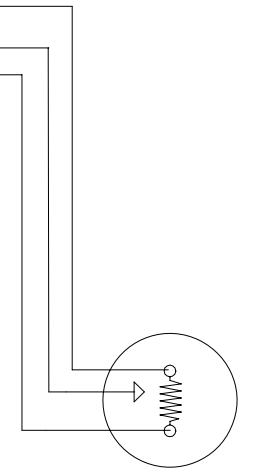

WIRING DIAGRAM

NOTES:
1. PART MUST BE LABELLED WITH PART NUMBER & REVISION
ON ENCLOSURE. MINIMUM .250" TALL LETTERS.

ENGLISH

Q. A. SYMBOLS

- ★ = CATEGORY I
- ▲ = CATEGORY II
- = CATEGORY III
- = CATEGORY IV

MX

BANNER

| | | | | | | | | | |
|----------------------------------|--|------------------------------------|---------|-------------|--|-----------------------|--|---------------------|--|
| REL -- | | EC33483 | DS | CONTROL BOX | | DIS. CODE | | NAME | |
| Initial | | Release | 28JUN10 | CONTROL BOX | | DWN. | | STAHL | |
| REL -- | | #241186-235 | ---- | CONTROL BOX | | CK. | | ON FILE | |
| LT LC | | CHANGE | DATE | CONTROL BOX | | APR. | | ON FILE | |
| THIS DRAWING OR PRINT (1) IS THE | | PROPERTY OF TECUMSEH PRODUCTS | | CONTROL BOX | | SCALE | | 1:1 & NOTED | |
| UNLESS OTHERWISE SPECIFIED, ALL | | DIMENSIONS ARE IN INCHES. | | CONTROL BOX | | THIS PRINT SUPERSEDES | | ALL PRINTS PRIOR TO | |
| DIMENSIONS ARE TO BE TAKEN | | TO THE UNLESS OTHERWISE SPECIFIED. | | CONTROL BOX | | TECUMSEH PRODUCTS CO. | | DRAWING NO. | |
| SPECIFIC CONDITIONS THAT AFFECT | | THE INFORMATION CONTAINED | | CONTROL BOX | | TECUMSEH, MICHIGAN | | 030A0138 | |
| HEREIN SHALL BE DEEMED TO | | BE THE PROPERTY OF TECUMSEH | | CONTROL BOX | | MATERIAL | | NOTED | |
| AND SHALL BE RETURNED TO THE | | ORIGINAL SOURCE OF THE | | CONTROL BOX | | NOTED | | NOTED | |
| DRAWING OR PRINT (1) IS THE | | PROPERTY OF TECUMSEH PRODUCTS | | CONTROL BOX | | NOTED | | NOTED | |
| UNLESS OTHERWISE SPECIFIED, ALL | | DIMENSIONS ARE IN INCHES. | | CONTROL BOX | | NOTED | | NOTED | |
| DIMENSIONS ARE TO BE TAKEN | | TO THE UNLESS OTHERWISE SPECIFIED. | | CONTROL BOX | | NOTED | | NOTED | |
| SPECIFIC CONDITIONS THAT AFFECT | | THE INFORMATION CONTAINED | | CONTROL BOX | | NOTED | | NOTED | |
| HEREIN SHALL BE DEEMED TO | | BE THE PROPERTY OF TECUMSEH | | CONTROL BOX | | NOTED | | NOTED | |
| AND SHALL BE RETURNED TO THE | | ORIGINAL SOURCE OF THE | | CONTROL BOX | | NOTED | | NOTED | |
| DRAWING OR PRINT (1) IS THE | | PROPERTY OF TECUMSEH PRODUCTS | | CONTROL BOX | | NOTED | | NOTED | |
| UNLESS OTHERWISE SPECIFIED, ALL | | DIMENSIONS ARE IN INCHES. | | CONTROL BOX | | NOTED | | NOTED | |
| DIMENSIONS ARE TO BE TAKEN | | TO THE UNLESS OTHERWISE SPECIFIED. | | CONTROL BOX | | NOTED | | NOTED | |
| SPECIFIC CONDITIONS THAT AFFECT | | THE INFORMATION CONTAINED | | CONTROL BOX | | NOTED | | NOTED | |
| HEREIN SHALL BE DEEMED TO | | BE THE PROPERTY OF TECUMSEH | | CONTROL BOX | | NOTED | | NOTED | |
| AND SHALL BE RETURNED TO THE | | ORIGINAL SOURCE OF THE | | CONTROL BOX | | NOTED | | NOTED | |